

Operating manual

UNIQUE²

[HAZER]



a Look Solutions product

Set of Equipment supplied

- 1 **Unique²**
- 1 tank lid with quick connector, silicon tube and air valve filter
- 1 canister of UNIQUE-fluid, 2l
- 1 manual

As an option:

- XLR remote for analog control (delivered without cable)
 - Diverter
 - Case
 - Hanging set
 - Radio remote (for starting the HDCS profile only)
- Please check whether all the products you ordered are supplied.

Contents

1. Introduction	4
2. Safety instructions	5
3. Description of the parts	6
4. Fluid	7
4.1 General notes	
4.2 Changing the fluid canister	
4.3 Storage of the fluid	
4.4 Fluid consumption	
5. Operating the Unique²	9
5.1 Selecting the location	
5.2 Putting into operation	
5.3 Switching the device off	
5.4 Control choices	
5.4.1 Control via DMX 512	
5.4.1.1 Adjusting the DMX start address	
5.4.1.2 Adjusting the pump and the fan	
5.4.2 Control via 0 - 10 Volt (+) DC	
5.4.2.1 Adjusting the pump and the fan	
5.4.3 Stand alone mode	
5.4.3.1 Adjusting the pump and the fan	
5.4.4 Control via Haze-Density Control System (HDCS)	
5.4.4.1 Using the Profile	
5.4.5 Working with the internal Timer	
5.4.5.1 Autostart	
5.5 Wiring of the sockets	
6. Cleaning, Care and Maintenance	17
7. Troubleshooting	17
8. Specifications	18
9. Warranty conditions	19

1. Introduction

The haze machine **Unique²** offers various new features, which open new fields of operation to the user.

With its variable output, the machine can be used in many fields of operation. Any desired effect can be achieved: from the finest mist to a thick haze, similar to fog. Therefore the **Unique²** is able to fill rooms or halls with a constant haze, creating the right atmosphere and is greatly enhancing lighting effects.

The pump and the fan are fully and separately controllable, giving the **Unique²** a good level of noise reduction. The machine can therefore be used in fields of operation where any sound is undesirable or causes disturbance.

The ready-mixed fluid, available in canisters of 2 litres, guarantees a trouble-free operating and continuous output for up to 50 hours.

The warm up time is extremely short (max. 1 min.)

With its power requirement of 1300 watt the **Unique²** is very powerful.

2. Safety instructions

A fog machine is not a toy!

- Very hot steam escapes from the nozzle. Danger of getting burnt.
- Occasionally very hot droplets of fluid may escape when in operation. Thus never aim at persons directly and keep a minimum distance of 10 ft to the nozzle.
- Never touch the nozzle when in operation. Danger of getting burnt.
- The location for the machine must be non-flammable, non-combustible and not sensitive to heat. It has to be twice as big as the machine.
- Keep a minimum distance of 2 ft to all flammable, combustible objects and objects sensitive to heat.
- Never open the machine and leave the machine unattended when connected to a power supply.
- The visibility has to be more than 6 ft in rooms where people walk around.
- Only use the supplied „UNIQUE-fluid“. Different types of fluid do not generate the fog you require and destroy your fog generator.
- Do not swallow the fog fluid. Keep it away from children. In case of eye contact, rinse with a lot of water. Consult a doctor should you have accidentally swallowed some fluid.
- Spilled fluid or splashed fluid droplets can cause slip hazard. Mop up the fluid and dispose of it according to regulations. UNIQUE-fluid is completely water-soluble and biodegradable.
- Fog may activate smoke detectors.

Artificially-made fog can be produced in many different ways. The method used here to produce fog, with a device which works according to the vaporizer principle, is the most harmless one.

No case has so far been reported in which a sound human being has been harmed because of using our device to produce artificial fog. However, this can only be guaranteed if the professional fog generators are used accordingly, i.e. at the correct vaporization temperatures as well as with the correctly mixed fog fluid.

We, however, recommend: **People with health problems or problems of the respiratory tract or with an inclination for allergies should avoid any contact with artificially-made fog.**

3. Description of the parts

Rear view

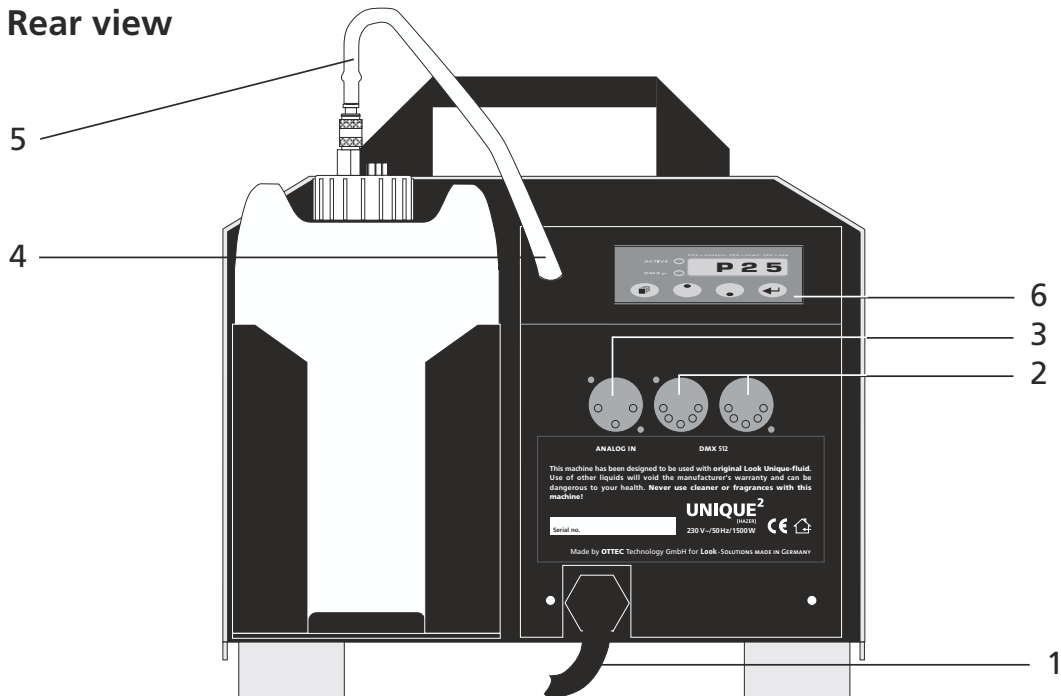

- 1: · Power cable
- 2: · XLR sockets for DMX in/out
- 3: · XLR socket for 0-10 V (+) DC
- 4: · Fluid tube inlet

- 5: · Fluid tube
- 6: · Control panel for adjusting the DMX start address and the output

Front view

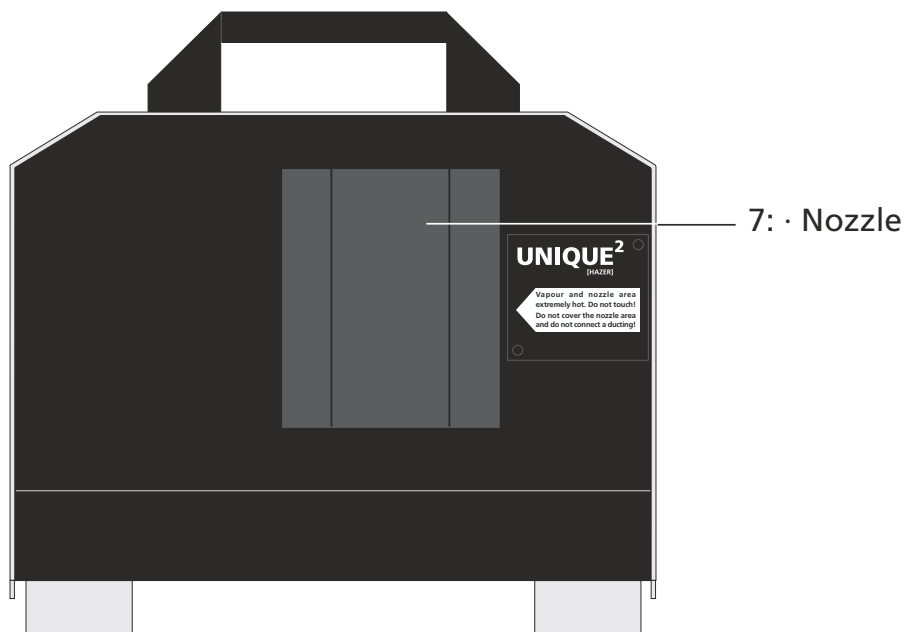

3. Description of the parts

Tank lid

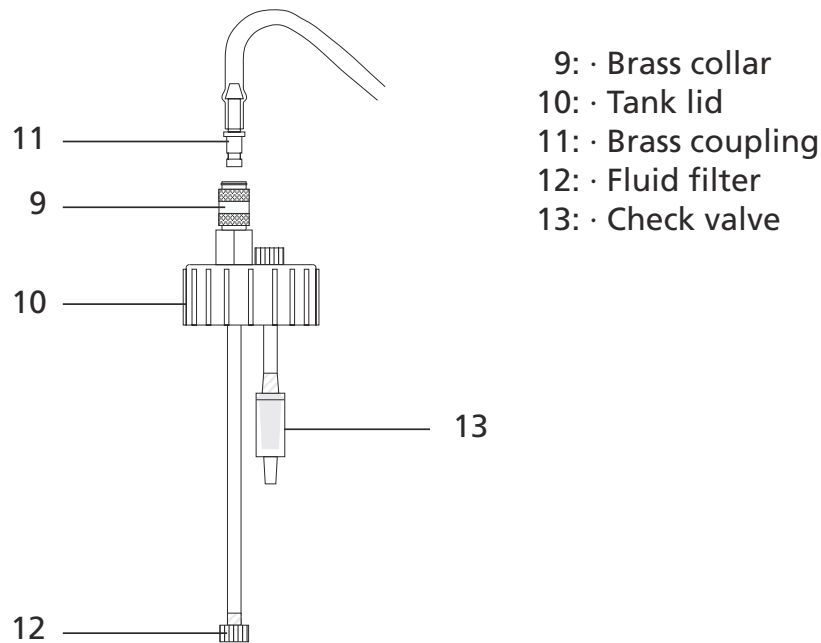

4. Fluid

4.1 General notes

The ready-to-use UNIQUE-Fluid for use in the **Unique²** is available in 2 litre canisters from your local dealer. Fluid also comes in 10 and 25 litre canisters and barrels with 220 litres.

To guarantee trouble-free operation the special "UNIQUE-Fluid" must be used. Use of other liquids will void the manufacturer's warranty and can be dangerous to your health.

PLEASE NOTE: The vaporizer of our machines does not have to be cleaned! Cleaners, available on the market, can damage the vaporizer! We cannot grant warranty in this case.

4. Fluid

4.2 Changing the fluid bottle

- Disconnect the fluid tube from the lid by retracting the brass collar [9] and removing the brass coupling [11].
- Remove the container from the tank housing of the **Unique²**.
- Unscrew the lid [10] of the empty container and screw it onto the new container.
- Place the full container into the tank housing.
- Push the brass coupling [11] into the brass collar [9], until you hear a click. The brass collar is now locked firmly.

4.3 Storage of the fluid

The “UNIQUE-Fluid” is a highly concentrated fluid (but do not dilute it). You can store it for a very long period.

4.4 Fluid consumption

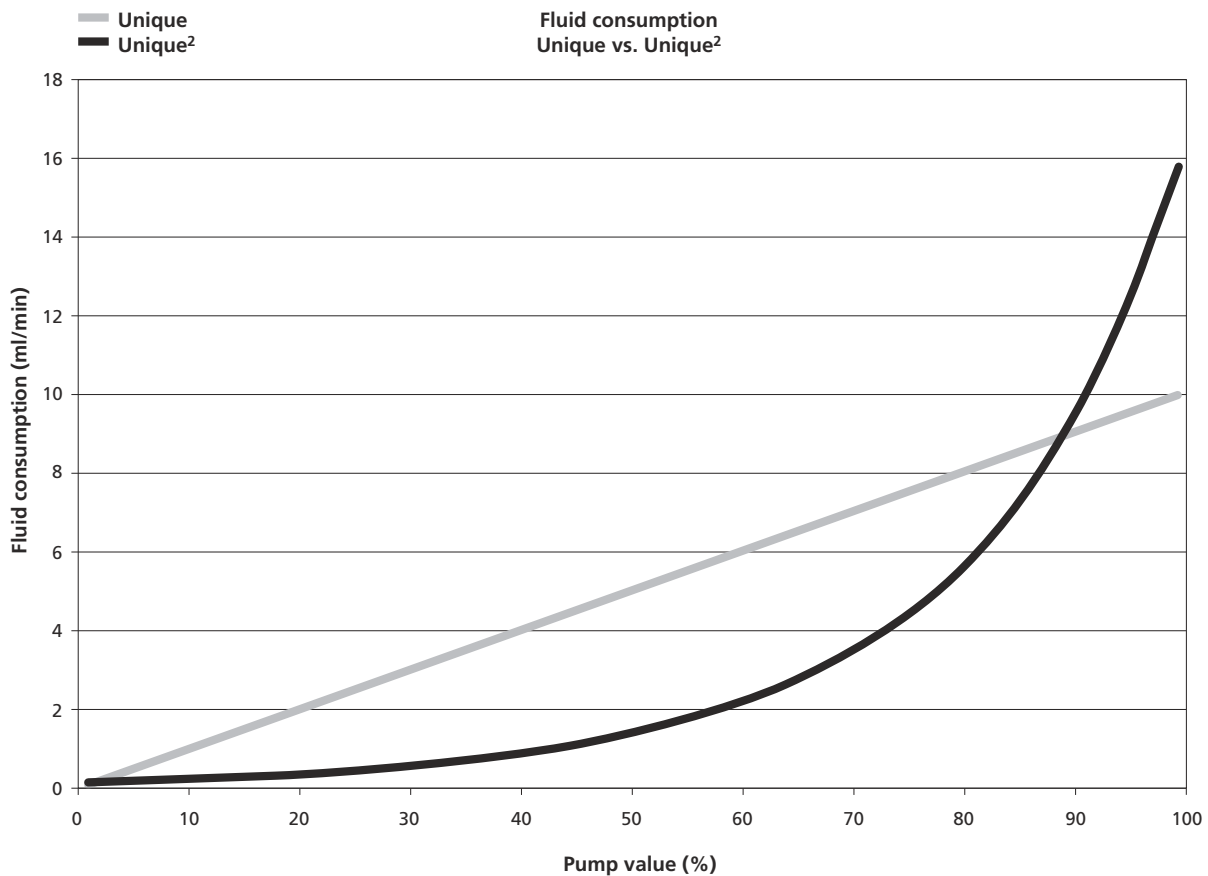

5. Operating the Unique²

From the finest mist to a thick haze, similar to fog, any desired effect can be achieved. These haze effects form slowly so that the device should be switched on some time before the lighting or the laser start to operate.

Important: Do not connect a ducting to the nozzle of the Unique². If a ducting is connected directly to the machine the haze will be pushed back into it. This may damage the machine. We cannot grant warranty in this case!

5.1 Selecting the location

The location in which the Unique² is to be operated must

- be dry,
- be free from dusty or polluted air,
- be free from vibrations,
- be a non-flammable place or surrounding,
- be well-ventilated with haze-free air keeping the ambient operating temperature between 50° F and 105° F and the relative humidity below 80%.

5.2 Putting into operation

Warning: Never connect the Unique² to a dimmer or switchpack! This may destroy the machine.

- a. Connect the power plug to an electrical outlet.
Make sure the outlet has the correct voltage for your machine.
A P and two figures appear on the LED display [17].



- b. After 60 Seconds, the Unique² is heated up. Press the Enter button [16] once to start the haze process. The green Active LED [18] will be lit. After a short delay the machine begins to haze.

After 30 Seconds the display will go dark. To re-activate it, press one of the buttons on the display.

5. Operating the Unique²

5.3 Switching the device off

- a. Press the Mode button [14] till „OFF“ appears on the display. After 15 Seconds the machine will switch off automatically. On the right bottom edge of the display a red decimal point will appear.



You can also switch off the machine within these 15 Seconds by pressing the Enter button [16].

- b. When you switch off the DMX signal, the machine will be switched off automatically after 15 Seconds.

Note:

Please make sure that the Unique² will not be disconnected too early to allow the fan to run until the device has cooled down. This will ensure that no fluid remains in the vaporizer to come out as droplets when the device is switched on next time.

5.4 Control choices

20: Profile/

Timer-LED, red

18: Active-LED, green

19: DMX-LED, yellow

14: Mode button

15: Up/Down button

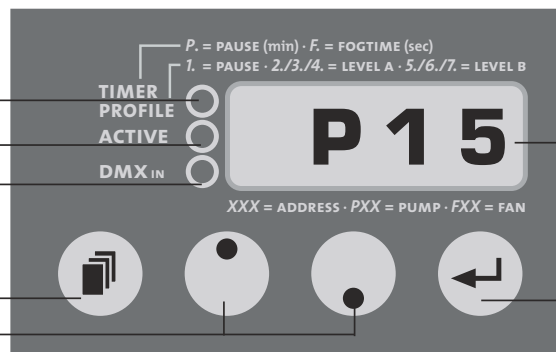

17: Led display

16: Enter button

Fig. 1: Adjusting the pump output

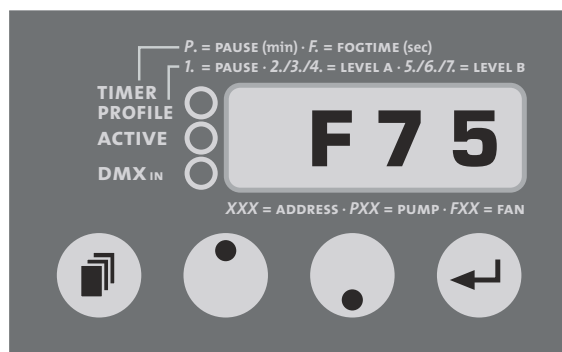

Fig. 2: Adjusting the fan output

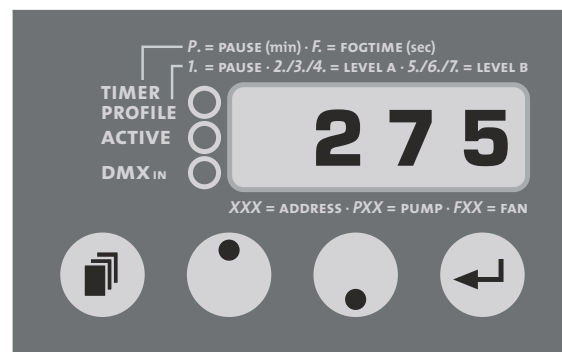

Fig. 3: Adjusting the DMX-start address

5. Operating the Unique²

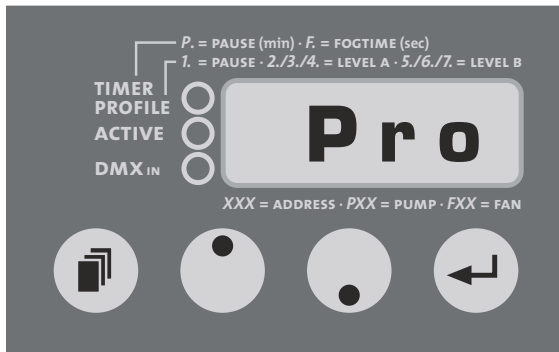

Fig. 4: Changing to the Profile-Mode

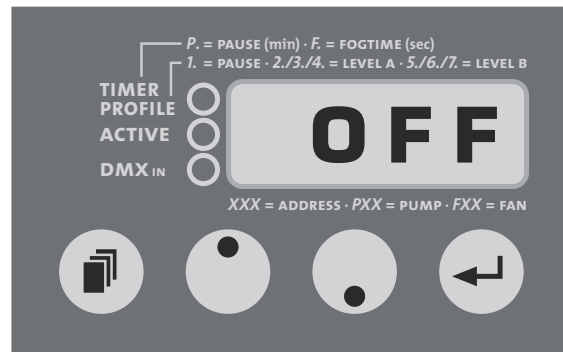

Fig. 5: Switching the device off

You may control the **Unique²** externally through the XLR sockets [2 and 3].

Please note: DMX takes priority. That means: when the machine is controlled via DMX 512 this data takes priority over 0-10V (+) DC and Stand alone operation.

Please note: You can't hold down the Mode-button for scrolling through the Menu. The Mode-button must be pressed only momentarily. If the Mode button is pressed more than two Seconds, the machine will change into the Timer-Mode (see point 5.4.5).

An outstanding feature is the adjustable output of the **Unique²**. The pump and the fan can be easily and separately adjusted and regulated in 99 steps via buttons. Any desired effect can be achieved in steps of 1%: from the finest mist to a thick haze, similar to fog. To achieve the thickest effect the pump must run at 99%, the fan at 1%. The finest haze can be achieved with lower pump and higher fan settings. The data can be readjusted whenever you want to.

5.4.1 Operating via DMX 512

Connecting the **Unique²** to a DMX desk, use the XLR socket [2] beside the control panel. As soon as the machine receives a correct DMX signal, the yellow DMX-LED [19] will be lit.

Please note: The **Unique²** uses two channels on your desk! First Channel = Pump, second Channel = Fan

5.4.1.1 Adjusting the DMX start address

a) Press the Mode button [14] at the control panel until three figures appear on the LED display [17] (see Fig. 3).

5. Operating the Unique²

- b) Adjust the required start address by pressing the Up or Down button [15].
- c) Save the start address by pressing the Enter button [16] once. The start address will now also be saved when you disconnect the machine from the mains supply.

5.4.1.2 Adjusting the pump and fan output

If you run the machine via a DMX desk you can adjust the pump and the fan directly from the desk from 1 to 99%.

If you change the DMX start address, the newly selected channel controls the pump and the next channel controls the fan.

5.4.2 0 - 10 Volt (+) DC control

Connect the **Unique²** to an analog desk or the cable remote which you can get as an option, using the XLR socket at the back of the machine [3].

Please note: With analog control the pump can be adjusted from the desk and/or the cable remote. The fan has to be adjusted at the machine.

- a) Put the cable from the desk or the cable remote into the XLR socket at the back of the machine [3].
- b) Put the pump up to 99% and adjust the required fan output at the machine (see chapter 5.4.2.1).
- c) With the rotary control on the cable remote or with the fader on the analog desk the pump output can be regulated.
- d) Pressing the On/Off switch at the cable remote starts the haze process. The green Active-LED [18] will be lit.

5.4.2.1 Adjusting the pump and fan output

- a) Press the Mode button [14] at the control panel until a P and two figures appear on the LED display [17] (see Fig. 1). Put the pump up to 99%.
- b) Press the Mode button [14] at the control panel until an F and two figures appear on the LED display [17] (see Fig. 2).
- c) Adjust the desired data (1 - 99%) by pressing the Up or Down button [15].
- d) The data for the pump can be regulated/adjusted via the rotary control on the cable remote and the fader on your analog desk.

5. Operating the Unique²

5.4.3 Stand alone

The Unique² can be used in the Stand alone mode. In this mode all data for the pump and the fan must be adjusted directly at the machine.

5.4.3.1 Adjusting the pump and fan output

- Press the Mode button [14] at the control panel until a P and two figures appear on the LED display [17] (see Fig. 1).
- Adjust the desired data (1 - 99%) by pressing the Up or Down button [15].
- Press the Mode button [14] again until an F and two figures appear on the display [17] (see Fig. 2).
- With the Up or Down button [15] the fan data can now be adjusted.
- Press the Enter button [16] once to start the machine. The green Active-LED [18] will be lit.

5.4.4 Haze-Density Control System (HDCS)

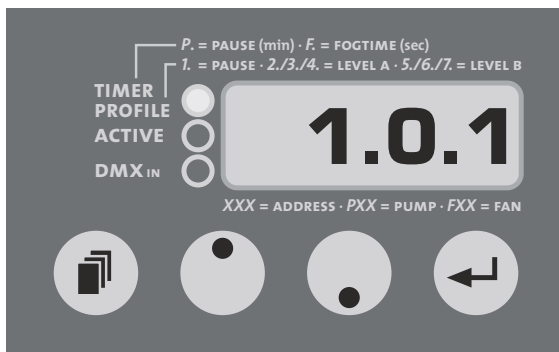

Fig. 6: Adjusting the Pause (Pre-Runtime)

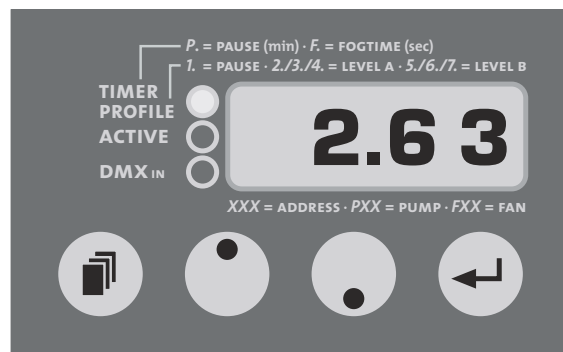

Fig. 7: Adjusting the pump

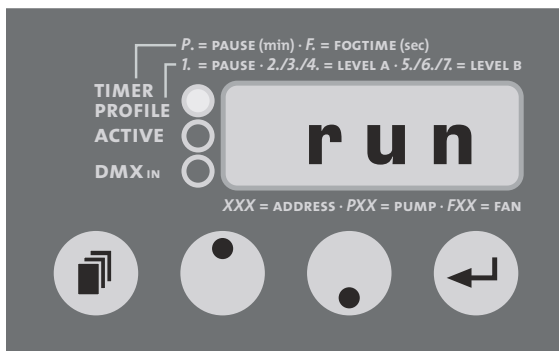

Fig. 8: Start the profile



Fig. 9: Quit the profile

5. Operating the Unique²

The HDCS allows you to program a profile for a show. You can set two output levels and a run-time for each, along with an initial Pause-time.

A Profile consists of seven settings: Setting #1 is the pause-time, settings #2 - 4 are for Level A (pump, fan and run-time), and settings #5 - 7 are for Level B (pump, fan and run-time).

For example: You want the machine to run at full output (P 99% / F 99%) for 10 Minutes immediately before the show begins (Level A), and then you want the machine to run at a lower output (P 05% / F 50%) for the duration of the 60 Minutes show (Level B). Program these two Levels into the HDCS profile, along with a 20 Minute pause-time. Activate the Profile 30 Minutes before each show.

The following Profile settings can be programmed:

1. Pause (Pre-Runtime)	0 - 99 min	5. Pump (Level B)	1 - 99 %
2. Pump (Level A)	1 - 99 %	6. Fan (Level B)	1 - 99 %
3. Fan (Level A)	1 - 99 %	7. Run-Time (Level B)	0 - 99 min
4. Run-Time (Level A)	0 - 99 min		

5.4.4.1 Using the Profile

- Press the Mode button repeatedly [14], until „Pro“ appears on the display (see Fig. 4).
- Press the Enter button [16] once to switch to the HDCS Menu. The red Timer/Profile-LED [20] will be lit.
- Adjust settings 1 to 7 according to the chart on page 15, using the Up/Down buttons [15] and pressing the Mode button to switch between the settings. These settings are stored in non-volatile memory. You don't have to run the Profile or press the Enter button in order to „save“ the settings. All settings can be changed as described at any time.
- To start the Profile with the adjusted values, press the Mode button [14], until „run“ appears on the display (Fig. 8), then press the Enter button [16]. The Timer/Profile-LED [20] flashes, indicating that the Profile is running. The green Active-LED [18] lights as soon as the adjusted Pause (Pre-Runtime) has passed and level A has started. The Profile can also be started via an optional radio remote.
- To leave the HDCS menu or quit the Profile, first press the Mode button until „ESC“ appears on the display (Fig. 9). Then press the Enter button [16] once to return to the main menu.

5. Operating the Unique²

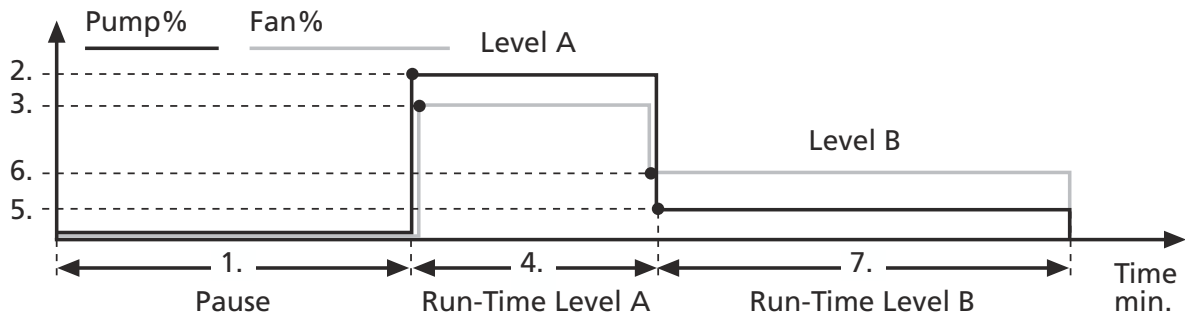

5.4.5 Operating the internal Timer

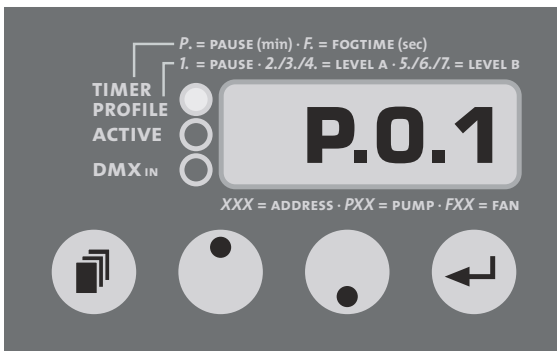

Fig 10: Adjusting the Pause (Wait-Time)

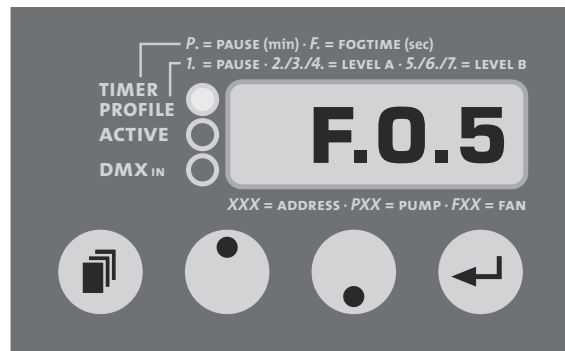

Fig. 11: Adjusting the haze time

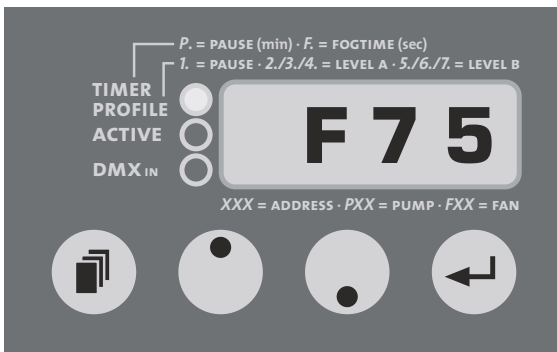

Fig. 12: Adjusting the fan

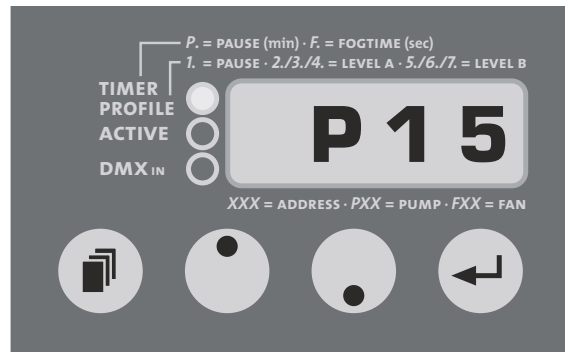

Fig. 13: Adjusting the pump

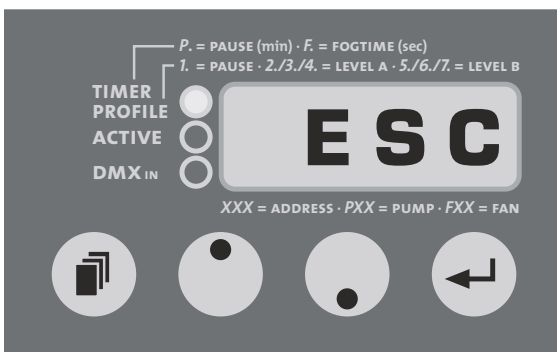

Fig. 14: Quit the Timer-Mode

5. Operating the Unique²

With the internal timer, the haze time and wait time can be adjusted in Minutes (0.1 - 99), the pump and fan output can be adjusted in per cent (0 - 99).

To start the Timer-Mode, press and hold the Mode button [16] for more than 2 Seconds. The red Timer/Profile-LED [19] will blink as soon as the machine has switched to the Timer-Mode. As long as the timer is in operation, the red Timer/Profile-LED blinks.

The adjusting of the output, haze time or wait time is the same as in the Standard-Menu. This means you have to press the Mode button repeatedly until you reach the required function.

With the Up/Down buttons you can adjust the required functions, then press the Enter button to start the timer. Please note that P and F control Pump and Fan, whereas P. and F. control Pause time and Haze (Fog) time (Figs. 10 - 13).

The timer cycle starts with the time shown on the display when you press the Enter button (i. e. P.xx = Starts with wait time, F.xx = Starts with haze time). The timer cycle will not start if you press the Enter button while the pump or fan output setting is shown on the display.

You can switch back to the Standard-Menu by pressing the Mode button [14] for more than 2 Seconds or by pressing the Mode button repeatedly until „ESC“ shows on the display and then press the Enter button once.

5.4.5.1 Auto start

If the timer is in operation and you unplug the machine from the power outlet, the **Unique²** will re-start in the Timer-Mode as soon as it's reconnected. To stop this press the Mode button [14] for more than 2 Seconds or by switching to „ESC“ in the Timer-Mode and then press the Enter button.

Please note that if you disconnect the power to the machine during the haze/fog time, then a bit of wet residue will be blown from the heater when the machine is first turned on again, so disconnect the machine during a pause time instead of a fog time if possible. To avoid any possibility of residue, use the shutdown procedure in section 5.3 and do not use Auto start.

5.5 Wiring of the sockets

5pin XLR (DMX):

Pin 1 = Ground, Pin 2 = DMX -, Pin 3 = DMX +

3pin XLR (analog):

Pin 1 = Ground, Pin 2 = 0-10 V + DC in, Pin 3 = 12 V + DC out, max. 50 mA

6. Cleaning, Care and Maintenance

- Remove the filter, which protects the fan against dust and dirt, from time to time and clean it.
- After several hours of operation, some droplets of condensation will have formed at the nozzle. That is normal and not a malfunction.
Please note: Remove fluid droplets at the nozzle only when the machine has completely cooled off. During operation the nozzle gets very hot!
- Do not let the **Unique²** run without any fluid as the pump will run dry.
- Check the state of the fluid filter [12] from time to time and clean or replace it when necessary.
- **PLEASE NOTE:** The vaporizer of our machines does not have to be cleaned! Cleaners, available on the market, can damage the vaporizer! We cannot grant warranty in this case.

7. Troubleshooting

- Trouble:** The pump runs, but little or no haze is produced.
Cause: The pump sucks no or too little fluid.
- Check whether the canister is empty
 - Check whether the brass collar is properly connected with the brass coupling
 - Check whether the fluid filter in the canister is clogged
 - Check whether the fluid tube is twisted or defective
- Trouble:** The yellow LED at the machine does not light up (when running via DMX)
Cause: Connection from the machine to the desk is faulty.
- Check whether the plug is plugged in correctly
 - Check whether the cable is defective
 - Check whether the DMX start address is adjusted correctly
- Trouble:** During operation the **Unique²** fails to work for a long time
Cause: The overtemperature protection device is activated.
- Check whether the fan is clogged

7. Troubleshooting

Trouble: E-4 appears on the LED display
Cause: The machine is getting too hot. The heating switches off and the machine cools down.
Solution: Disconnect the machine from the mains supply for a moment and then re-connect it.

E - 4

Trouble: E-8 appears on the LED display
Solution: The vaporizer is clogged.
Cause: Please send the machine to the service-station or your local dealer.

E - 8

Trouble: E-1 appears on the LED display
Solution: Please send the machine to the service-station or your local dealer.

E - 1

8. Specifications

Procedure:	Haze machine without compressor
Power requirement:	1300 Watt
Voltage:	120 V/ 60 Hz
Warm up time:	approx. 60 Seconds
Fluid tank capacity:	2 liters
Integrated Fan:	> 6000 l/min.
Haze density:	variable
Control:	DMX 512 0 - 10 V analogue cable remote (option)
Dimensions (L x W x H):	18.5 x 10 x 10 ft
Manufactured for:	Look Solutions - Fog machines made in Germany

9. Warranty Conditions

For the haze machine **Unique² Look'** guarantee is:

1. Free of charge, subject to the following conditions (No. 2 - 6) we will repair any defect or fault in the unit if it is caused by a proven factory fault and has been advised immediately after appearance and within 12 months of delivery to the end user. Insignificant deviations of the regular production quality does not guarantee replacement rights, nor do faults or defects caused by water, wrong fog fluid, by generally abnormal environment conditions or Force Majeure.
2. Guarantee Service will be done in the following way: Faulty parts will be repaired or replaced (our choice) with correct parts. Faulty units have to be brought to us or our service centres or to be sent to us or our service centres at customer's expenses. The invoice and/or receipt showing the purchase date and the serial number has to come with the faulty unit, otherwise this will not be guarantee service. Replaced parts become our property.
3. The customer loses all rights for guarantee services, if any repairs or adjustments are done to the units by unauthorized persons and/or if spare parts are used which are not approved by us. The right of guarantee service is also lost if fluids other than the original „UNIQUE-fluid“ have been used or if units are sent to us with full fluid bottles. Also non compliance with the instructions in this manual or mistakes by incorrect handling/treating of the machine will lead to a loss of guarantee and also any faults and damages caused by undue force.
4. Certain parts of the machine are „consumable parts“ and are not covered by the warranty.
5. Guarantee services do not cause an extension of the guarantee time or the start of a new guarantee time. The warranty for replaced parts ends with the guarantee time of the whole unit.
6. We may, at our option, replace the machine rather than repair it.
7. Further claims, especially for damages, losses etc. outside the unit are excluded.

Other guarantee regulations may be valid outside the USA. Please check with your dealer!

If you should send the unit for service, do not forget to remove any liquid from the fluid bottle.

For warranty service in North America contact:

Look Solutions USA Ltd.
1-800-426-4189
usa@looksolutions.com

